

# TECHNICAL SPECIFICATIONS

# CUTTER G4

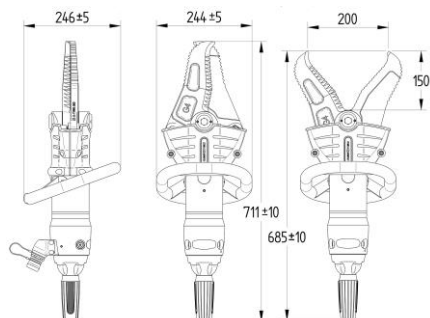

## CUTTER G4

NEO1 

HP/FF 

Nominal pressure	UltimatePressure™ 350 Bar	UltimatePressure™ 350 Bar
Tailhose safety factor	-	8:1 (2800 bar)
Dimensions (L x W x H)	711 x 244 x 246 mm	711 x 244 x 246 mm
Operational weight	12.6 kg	12.8 kg
Max. cutting opening	200 mm	200 mm
Reach	150 mm	150 mm
Max. cutting force	488 kN / 49.7 ton	488 kN / 49.7 ton
EN 13204	CC 200H-13	CC 200H-13
NFPA 1936	A6 B7 C6 D7 E7	A6 B7 C6 D7 E7

## ACCESSORIES

Art Nr.

LED light add-on

9500.1000



**PRESSURE™**  
**ULTIMATE**



**neo1**  
 TECHNOLOGY



Information contained in this document is believed to be accurate. However RESQTEC does not guarantee the completeness or accuracy of any of the published information.



**RESQTEC Zumro B.V.**  
 Meer en Duin 82 | 2163 HC Lisse, the Netherlands

**T** +31 (0)252 419002  
**E** info@resqtec.com

**F** +31 (0)252 411794  
**W** www.resqtec.com

**RESQTEC®**





CUTTING PERFORMANCE AS PER EN13204 TABLE 3 FOR CUTTERS AND COMBI TOOLS

DU002K00

Manufacturer	RESQTEC
Tool name and type	G4 CUTTER





CLAIMED CLASSIFICATION;

TYPE	CUTTER OPENING	CLASSIFICATION BASED ON MIN CUTTING PERFORMANCE	WEIGHT (1 decimal accurate)	CUTTING PERFORMANCE
CC	200	H	12.8	1H-2H-3H-4H-5H

PROFILE TYPE →	1 Round bar	2 Flat bar	3 Round tube	4 Square tube	5 Rectangular tube
CATEGORY LETTER ↓					
A	≥ 14	30 x 5	21,3 x 2,3		
B	≥ 16	40 x 5	26,4 x 2,3		
C	≥ 18	50 x 5	33,7 x 2,6	35 x 3	
D	≥ 20	60 x 5	42,6 x 2,6	40 x 4	50 x 25 x 2,5
E	≥ 22	80 x 8	48,3 x 2,9	45 x 4	50 x 30 x 3,0
F	≥ 24	80 x 10	60,3 x 2,9	50 x 4	60 x 40 x 3,0
G	≥ 26	100 x 10	76,1 x 3,2	55 x 4	80 x 40 x 3,0
H	≥ 28	110 x 10	76,1 x 4,0	60 x 4	80 x 40 x 4,0
I	≥ 32	120 x 10	88,9 x 4,0	60 x 5	80 x 40 x 5,0
J	≥ 36	130 x 10	88,9 x 5,0	70 x 4	100 x 50 x 4,0
K	≥ 40	140 x 10	101,6 x 4,0	70 x 5	100 x 50 x 5,0

CUTTING PERFORMANCE AS PER NFPA 1936 FOR CUTTERS AND COMBI TOOLS

A6 B7 C6 D7 E7

PROFILE TYPE →	A Round bar		B Flat bar		C Round pipe		D Square tube		E Angle iron		
PERFORMANCE LEVEL ↓											
	inch	mm	inch	mm	inch	mm	inch	mm	inch	mm	
1	3/8	9.5	1/4 x 1/2	6.4 x 13.7	3/8	0.68 x 0.09	17.2 x 2.2	1/2 x 0.06	12.7 x 1.5	1/2 x 1/8	12.7 x 3.17
2	1/2	12.7	1/4 x 1	6.4 x 25.4	3/4	1.05 x 0.11	26.6 x 2.79	1 3/4 x 0.06	19.1 x 1.5	1 x 1/8	25.4 x 3.17
3	5/8	15.8	1/4 x 2	6.4 x 50.8	1	1.32 x 0.13	33.5 x 3.3	1 x 0.08	25.4 x 2	1 1/4 x 3/16	31.7 x 4.8
4	3/4	19.1	1/4 x 3	6.4 x 76.2	1 1/4	1.66 x 0.14	42.2 x 3.2	1 1/4 x 0.12	31.7 x 3	1 1/2 x 3/16	38.1 x 4.8
5	7/8	22.2	1/4 x 4	6.4 x 101.6	1 1/2	1.90 x 0.15	48.3 x 3.2	1 1/2 x 0.12	38.1 x 3	1 1/2 x 1/4	38.1 x 6.35
6	1	25.4	3/8 x 3	9.5 x 76.2	2	2.38 x 0.15	60.5 x 3.8	1 3/4 x 0.12	44.5 x 3	1 3/4 x 1/4	44.5 x 6.35
7	1 1/4	31.8	3/8 x 4	9.5 x 101.6	2 1/2	2.88 x 0.20	73.2 x 5.1	2 x 0.15	50.8 x 3.8	1 1/2 x 3/8	38.1 x 9.5
8	1 1/2	38.1	3/8 x 5	9.5 x 126	3	3.50 x 0.22	88.9 x 5.6	2 1/2 x 0.19	63.5 x 4.6	2 x 3/8	50.8 x 9.5
9	1 3/4	44.45	3/8 x 6	9.5 x 152.4	3 1/2	4.00 x 0.23	101.6 x 5.8	3 x 0.19	76.2 x 4.8	2 1/2 x 3/8	63.5 x 9.5